



Heiligenstädter  
Reißverschluß

*solider verbinden.*

**PRODUCT**  
CATALOG

## **Tradition, competence, flexibility and innovation ...**

... are the characteristics of the Heiligenstädter Reißverschluß GmbH & Co. KG.

With a history which goes back to 1870 our company is combining the ideals of tradition with new ideas for the future. In the field of zipper production we can look back at experience gathered since 1935.

At our sole location in Heilbad Heiligenstadt/Thüringen we manufacture nearly our complete product range of zippers. Based on our high vertical range of manufacture we are able to realize customer-specific orders very fast and flexible.

The qualification and the high efficiency of our staff as well as our modern equipment guarantee the most possible precision in the production process and therefore a high quality of our products.

**Yours sincerely, Heiligenstädter Reißverschluß GmbH & Co. KG**





**Important companies of the clothing industry, leather goods industry, home- and household textiles industry and the camping industry belong to our customers.**



The icon “R” indents our products for more than 40 years. Since 2016 it is a fixed element of our company logo and it stands for **R**olid connections.

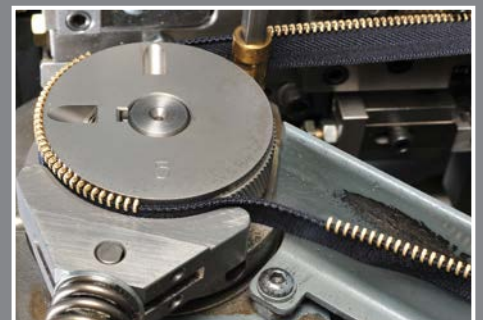
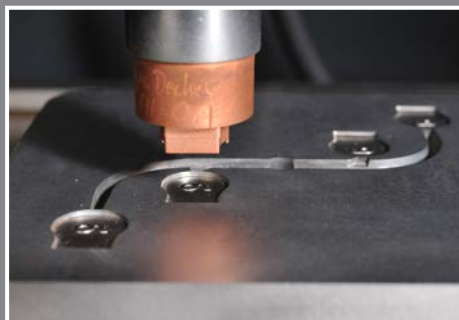
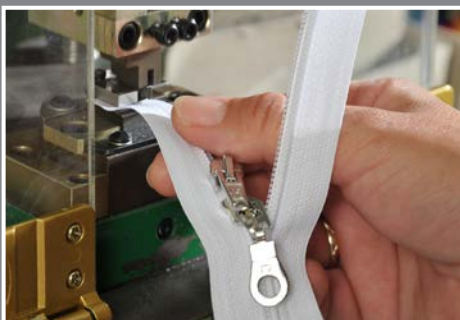

# Basics of the zipper

## Structure

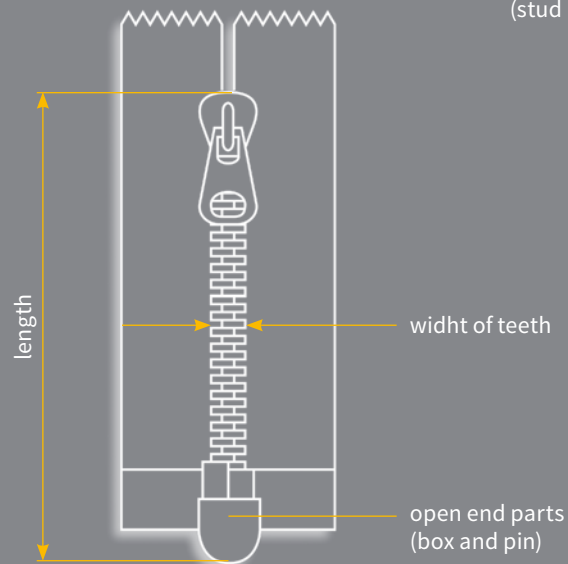
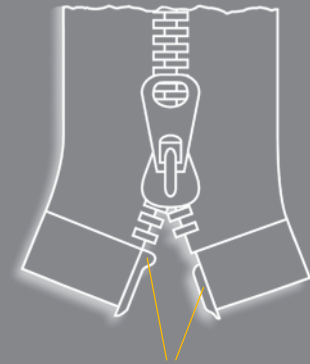
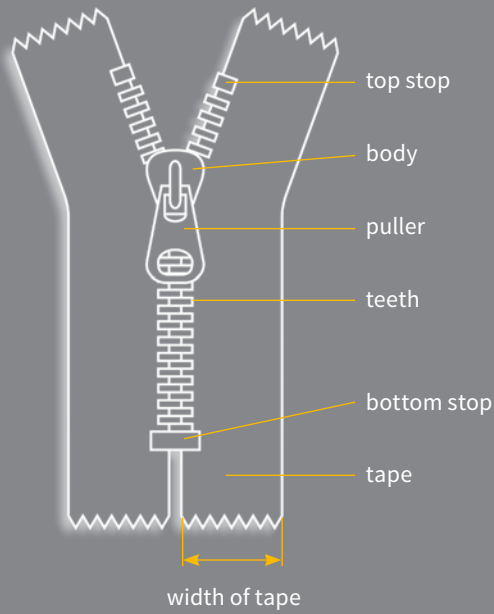

General information

## Types of sliders



automatic slider



semi-automatic slider



reversible automatic slider



non-locking slider with one puller



non-locking slider with double puller

## Types of zipper

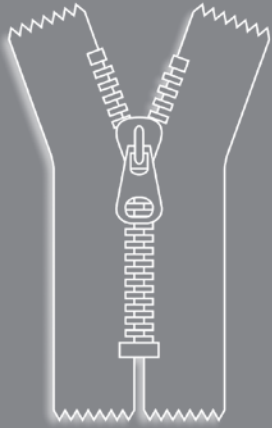

### Type A

closed end, 1 slider, deliverable in the following types:

PN0	PRO	P10
X	X	X
P20	P25	
X	X	
PK10	PK20	
X	X	
M0	M10	MS10
X	X	X

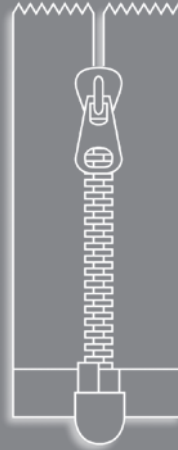

### Type B

open end, 1 slider, deliverable in the following types:

PN0	PRO	P10
	X	X
P20	P25	
X	X	
PK10	PK20	
X	X	
M0	M10	MS10
X	X	X

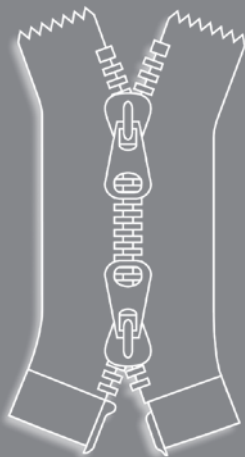

### Type C

2-way open end, 2 sliders, X-type, deliverable in the following types:

PN0	PRO	P10
	X	X
P20	P25	
X	X	
PK10	PK20	
X	X	
M0	M10	MS10
X		X

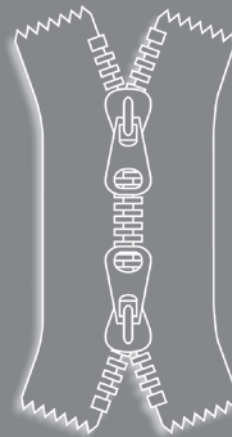

### Type D

2-way closed end, 2 sliders, X-type, 2 top stops at each end, deliverable in the following types:

PN0	PRO	P10
	X	X
P20	P25	
X	X	
PK10	PK20	
X	X	
M0	M10	MS10
X		X

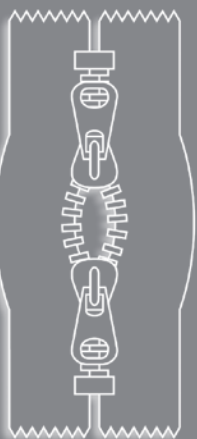

### Type F

2-way closed end, 2 sliders, O-type, 1 bottom stop at each end, deliverable in the following types:

PN0	PRO	P10
	X	X
P20	P25	
X	X	
PK10	PK20	
M0	M10	MS10
X		X

#### additional treatments are possible in our factory:

- welding off the ends of the zipper tape
- flame retarding finishing of zippers







**Polyester zipper**







## Basic types of automatic sliders

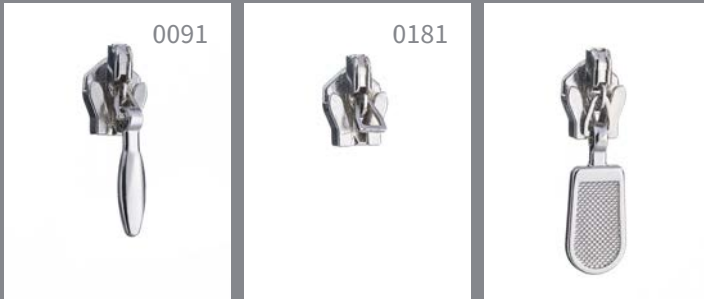

Tropfen

Zwischenglied

Eva

pullers of the pages 36-43 with \* can be mounted in galvanic surfaces only



## PNO

spiral width: 4.2 mm  
tape: 12.0 mm

for gentle clothing

from knitted fabric only

available as type A

## Specials



moveable bottom stop



combination with pullers lacquered in other colours possible





## Basic types of automatic sliders



Standard



Tropfen



konischer Griff

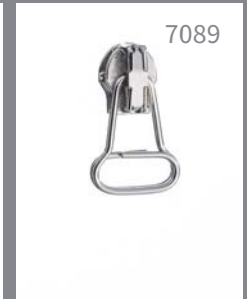

Drahtschleufe

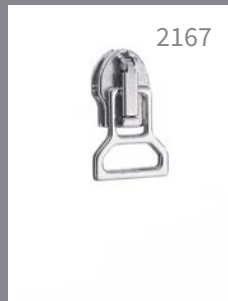

NA 100

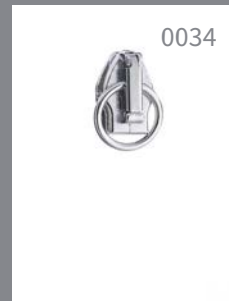

direkter Ring



Zwischenglied

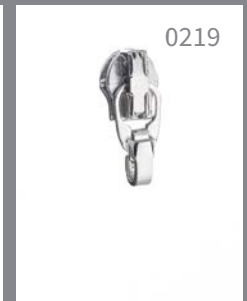

Karabinerhaken

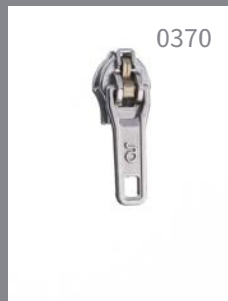

Semiautomatik

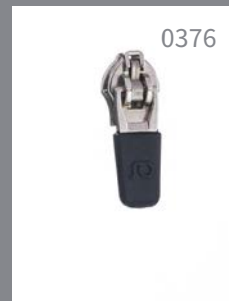

Semiautomatik mit  
gummiertem Griff  
schwarz

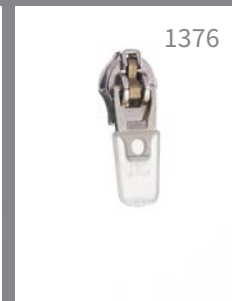

Semiautomatik mit  
gummiertem Griff  
transparent

## PRO

spiral width: 4.2 mm  
tape: 12.0 mm

for gentle clothing, small leather-  
ware, hometextiles, upholstery

available as type A, B, C, D, F

available as reverse zipper too  
(see page 17)

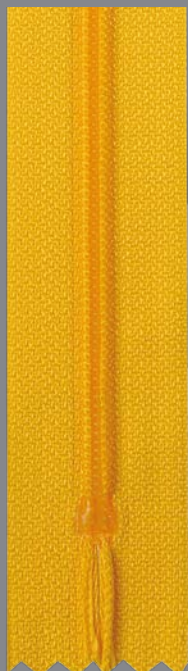



## Basic types of non locking sliders

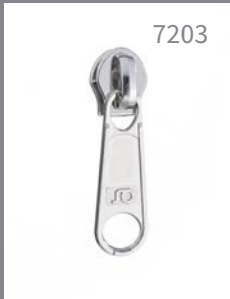

loser Bügelschieber

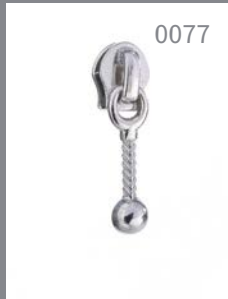

loser Kugelstab

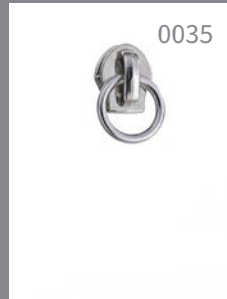

loser Bügelschieber  
mit Ring

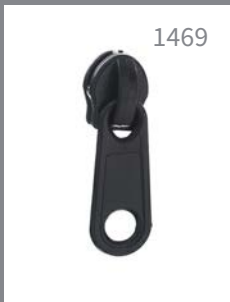

loser Bügelschieber  
plastic black  
(also possible in white)

## Bed linen sliders



Kunststoff weiß



Kunststoff schwarz



Metall silber



## PRO

spiral width: 4,2 mm  
tape: 12 mm

for small leatherware, hometextiles,  
bed linen

available as type A, B, C, D, F

available as reverse zipper too  
(see page 17)

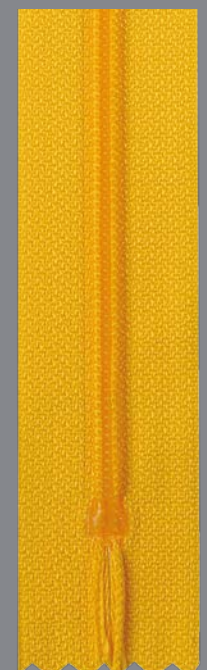

# Polyester zipper



## P 10

spiral width: 6,5 mm  
tape: 16 mm,  
20 mm only closed end zippers

for middle and heavier clothing,  
workwear, leatherwear,  
sportswear, upholstery,  
camping

available as reverse zipper too  
(see page 17)  
available as type A, B, C, D, F

for 2-way-zippers only for the top  
slider and plated surfaces only

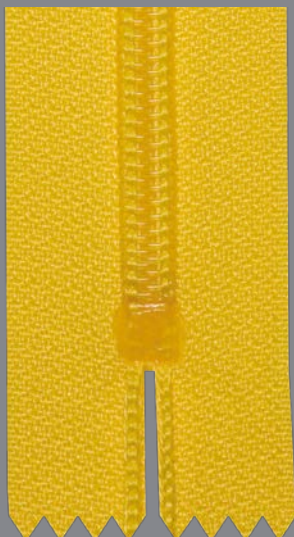

## Basic types of automatic sliders

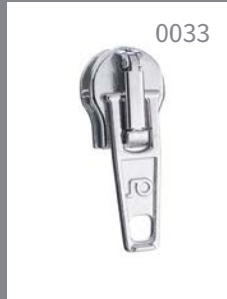

Standard

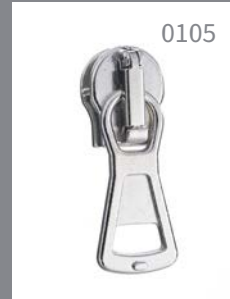

konischer Griff

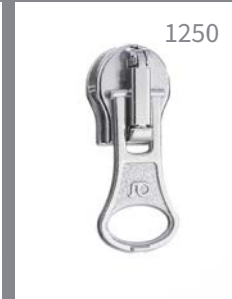

Löffelgriff



Leine

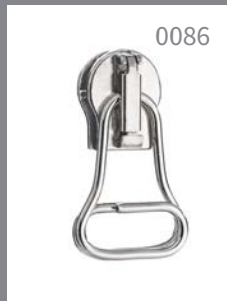

Drahtschlaufe

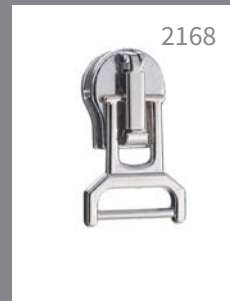

NA 113

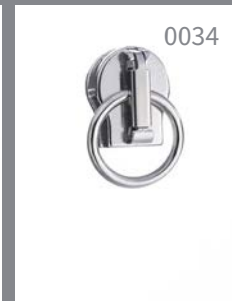

direkter Ring



autom.  
Wendeschieber

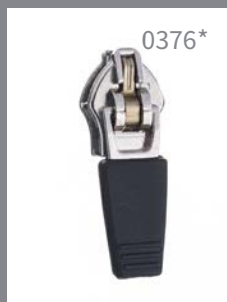

Semiautomatik mit  
gummiertem Griff  
schwarz



Semiautomatik mit  
gummiertem Griff  
transparent



Zwischenglied

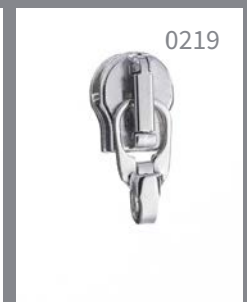

Karabinerhaken



Automatikschieber  
plastic black (also  
possible in white)  
not for 2-way-zippers



## Basic types of non locking sliders



loser Bügelschieber

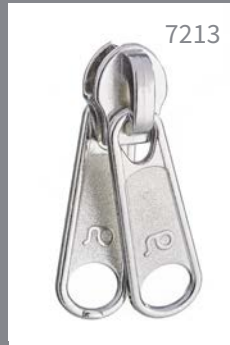

loser Wendeschieber

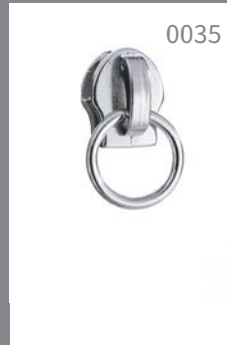

loser Bügelschieber  
mit Ring



loser Bügelschieber  
plastics black  
(also possible in white)  
not for 2-way-zippers



## P 10

spiral width: 6,5 mm  
tape: 16 mm,  
20 mm only closed end zippers

for leatherwear and camping

available as reverse zipper too  
(see page 17)

available as type A, B, C, D, F



# Zippers with plated spiral



## Zippers with plated spiral mPR 0 und mP 10



silver



silvergrey



gold



ice-gold

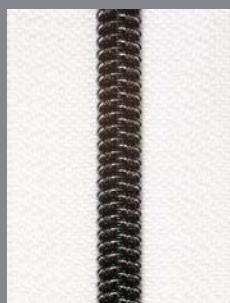

gun-metal

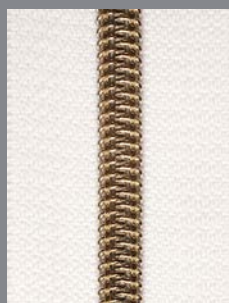

old brass

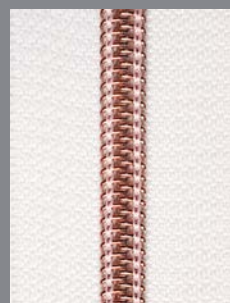

copper

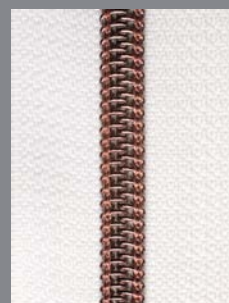

old copper

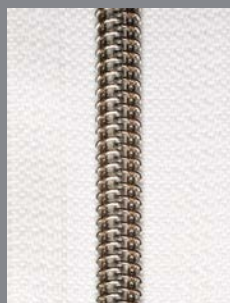

oxide



all surfaces with contrast sewing thread

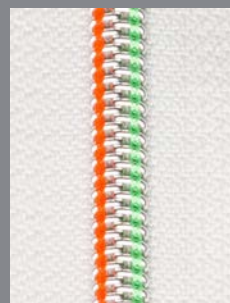

all surfaces with contrast sewing thread, bicoloured



pipng in all surfaces

### mPR 0

(spiral width like PR 0)

### mP 10

(spiral width like P 10)

selected colours of sewing thread can be chosen from Amann colour card for Serafil

typographical colour differences and those depending on production lots are possible

available as reverse zipper too (see page 17)

available as type A, B, C, D, F

## Lurex for P 10 only



Lurex Fb. 520



Lurex Fb. 521



Lurex Fb. 522  
not as 2-way open end zipper and only with slider 0105 or 0181 with puller

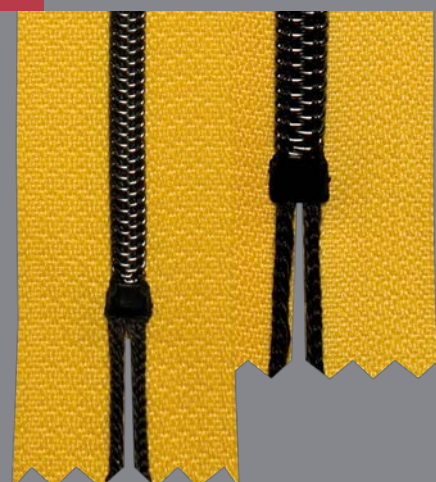



# Polyester zipper with transparent spiral

## with transparent spiral and coloured sewing thread



colour of sewing thread compatible to tape

colour of sewing thread in contrast to tape



## with transparent spiral and two-tone tape

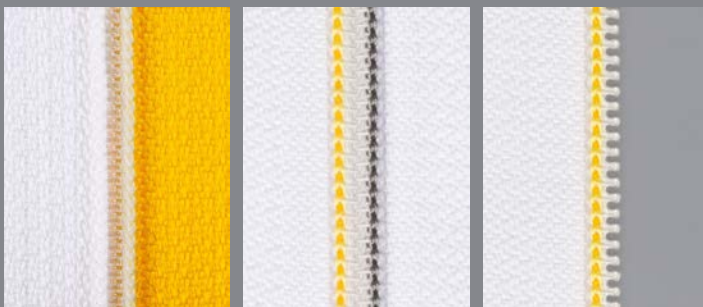

with left and right different-coloured tapes, with sewing thread coloured or white

with sewing thread in contrast bicoloured

piping

## P 10 with fishbone-tape



black/white

black/off-white with coloured sewing thread, transparent spiral

black/coloured

## trPR 0 / trP 10

with transparent spiral and coloured sewing thread

selected colours of sewing thread can be chosen from Amann colour card for Serafil

available as reverse zipper too (see page 17)

available as type A, B, C, D, F

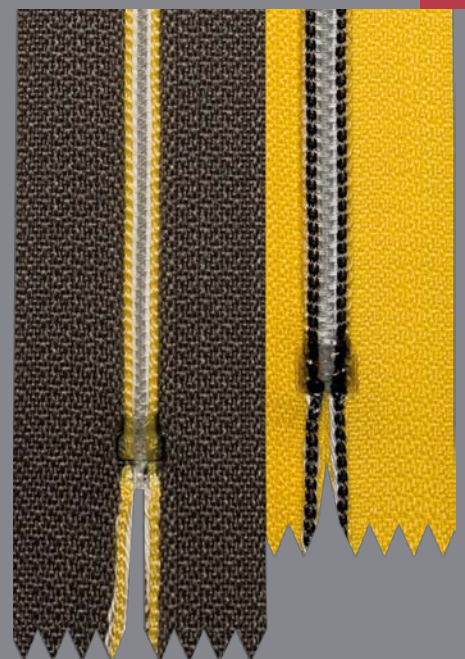

# Polyester zipper with reflective strips

Polyester zipper



black tape with woven in reflective strips 2 mm

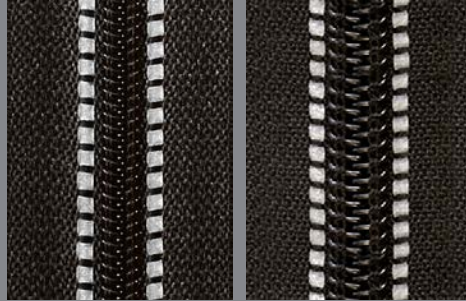

PR 0

P 10

## PR 0 / P 10

with reflective strips

available as type A, B, C, D, F

black tape with ironed on reflective stripes 5 mm

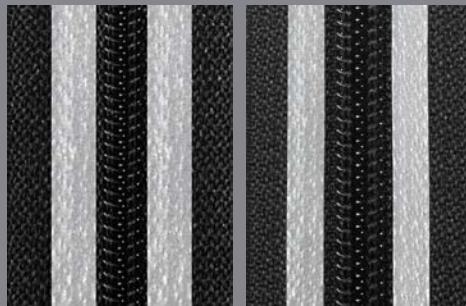

PR 0

P 10

black tape with ironed on reflective stripe 10 mm, reverse zipper

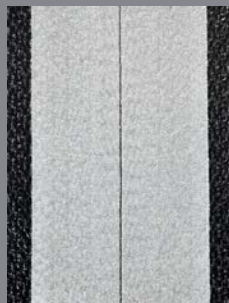

uP 10



You can find the pullers for these zippers on page 18.



uPR 0



uP 10



utrPR 0

with transparent spiral and contrast sewing thread



utrP 10

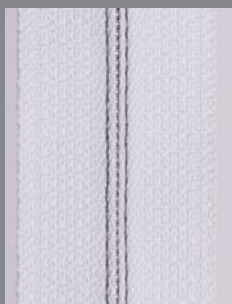

uimPR 0

with plated spiral inside

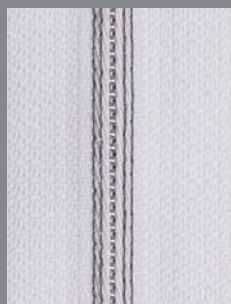

uimP 10



## uPR 0 / uP 10

reverse (without coating)

available as type A, B, C  
(only P 10), D, F

the range of colours is limited for  
reverse sliders

reverse zippers are unsuitable for  
processing in radii





# Polyester zipper reverse, waterproof-coated



## waPR 0 / waP 10

waterproof-coated

available as type A, B, C (only P 10), D, F

the range of colours is limited for reverse sliders

reverse zippers are unsuitable for processing in radii

no dry cleaning



### Basic types of reverse sliders PR 0

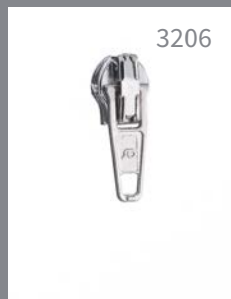

Standard

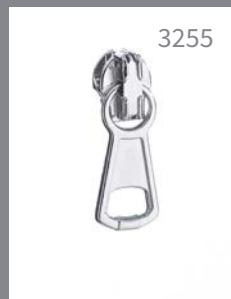

konischer Griff

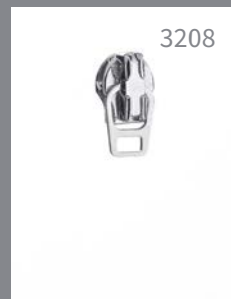

Zwischenglied

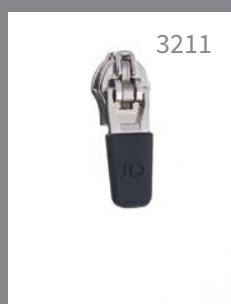

Semiautomatik mit gummiertem Griff schwarz

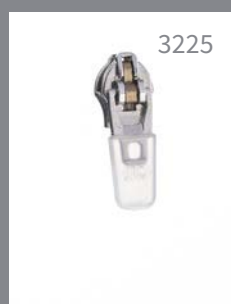

Semiautomatik mit gummiertem Griff transp.

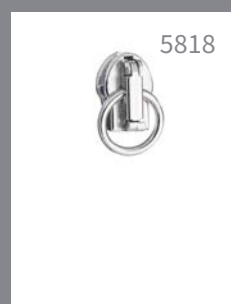

direkter Ring

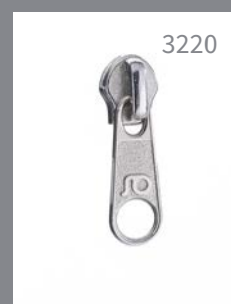

loser Bügelschieber

### Basic types of reverse sliders P 10



Standard



konischer Griff

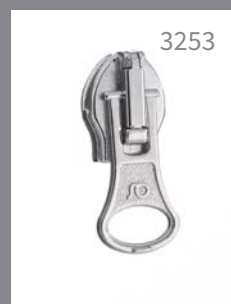

Löffelgriff

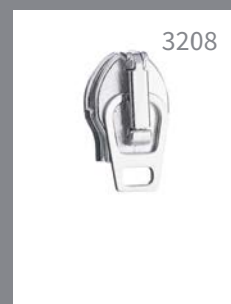

Zwischenglied

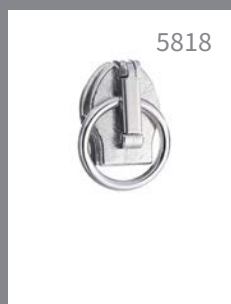

direkter Ring



Semiautomatik gummiert schwarz (also possible in transparent)

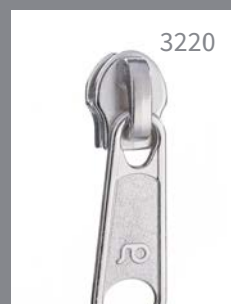

loser Bügelschieber



loser Bügelschieber Kunststoff schwarz (also possible in white)

\*not for 2-way open end zippers

# Polyester zipper coated with metal-look Polyester zipper with motive

You can find the pullers for these zippers on page 18.

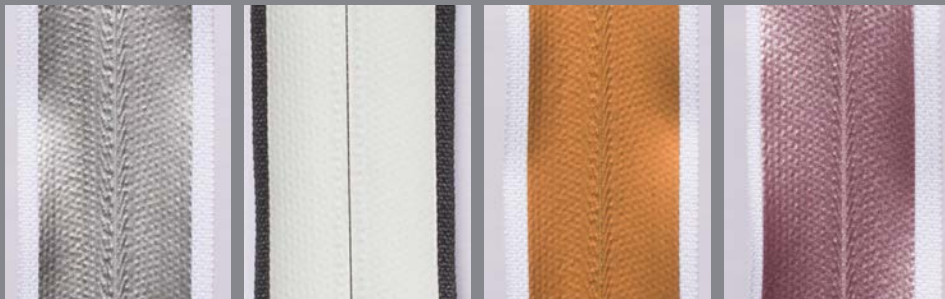

aluminium

white shiny

copper

pink



carbon

starlight-silver

starlight-gold



## wamPR 0 / wamP 10

coated with metal-look

available as type A, B, C  
(only P 10), D, F

## Motiv- verschlüsse

motifs and colours freely selectable  
available as type A, B, C, D, F  
not available as chain

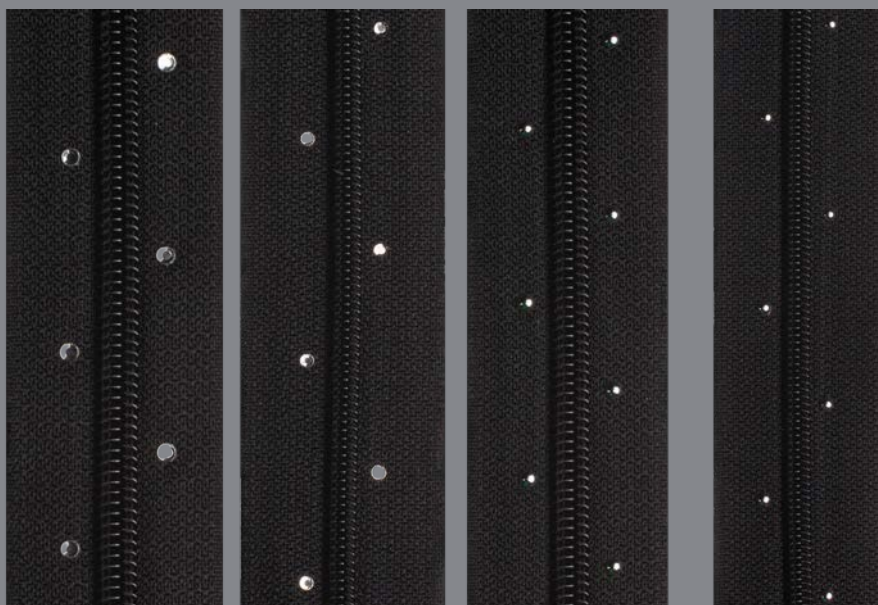

Straß/P 10

Straß/PR 0

alu/P 10

alu/PR 0





## P 20

spiral width: 8,5 mm  
tape: 20 mm

for heavy clothing, camping- and boat accessories, awnings, technical uses

available as type A, B, C, D, F and type E (2 open end parts, 2 sliders) G (2 open end parts, 4 sliders)

### Basic types of automatic sliders



Standard



Zwischenglied

### Basic types of non locking sliders



loser Bügelschieber



loser Wendeschieber



loser Bügelschieber mit Ring





Basic types of automatic sliders



0033

Standard, not for separable 2-way-zippers



0181

Zwischenglied, not for separable 2-way-zippers



P 25

spiral width: 10,5 mm  
tape: 20 mm

for camping- and boat accessories, awnings, technical uses

available as type A, B, C, D, F and type E (2 open end parts, 2 sliders)  
G (2 open end parts, 4 sliders)

Basic types of non locking sliders



8203

loser Bügelschieber



0211

loser Wendeschieber



1470

loser Bügelschieber, plastic, not for 2-way open end zippers



1473

loser Wendeschieber, plastic, not for 2-way open end zippers



Polyester zipper

# Printed zippers / printed spiral (thermosublimation printing technique)

Polyester zipper



## printed zippers

individual motifs for printing (e. g. writing, logo, illustration) possible for the following zippers:

- polyester zippers (zippers or chain):  
PR 0, uPR 0 (reverse), mPR 0 (plated), trPR 0 (transparent spiral) P 10, uP 10 (reverse), mP 10 (plated), trP 10 (transparent spiral)
- delrin zippers (zippers or chain): PK 10 and PK 20

## printed spiral

- colours for printing the transparent spiral (trPR0, trP10) can be selected from our colourcard
- only possible for dark tape colours



spiral



reverse spiral

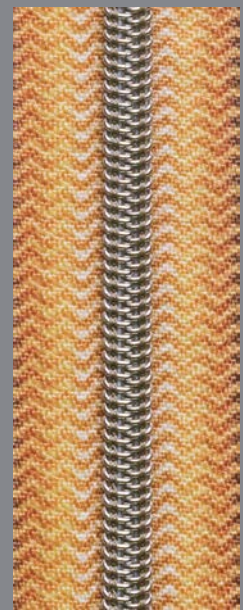

plated spiral

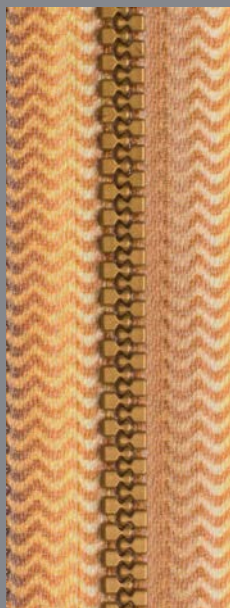

PK 10

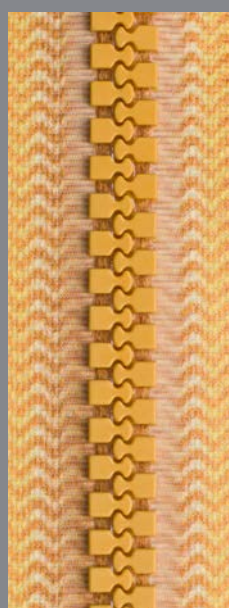

PK 20

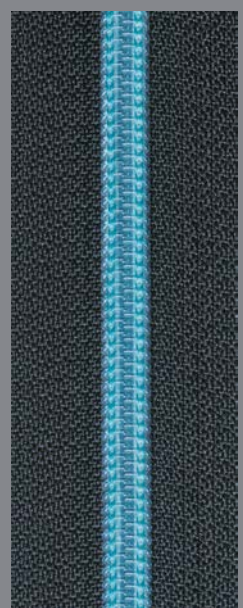

printed spiral





Delrin zipper





## PK 10

teeth: 5,8 mm  
tape: 15 mm,  
20 mm for chain

for middle and heavier clothing,  
sportswear, workwear

available as type A, B, C, D

plated surfaces only, with limited  
range of colours

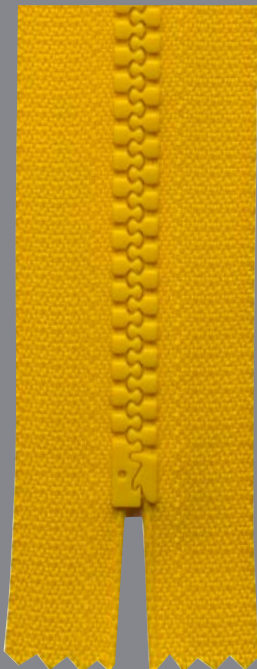

### Basic types of automatic sliders



Standard

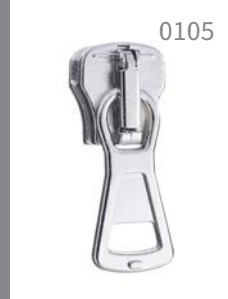

konischer Griff

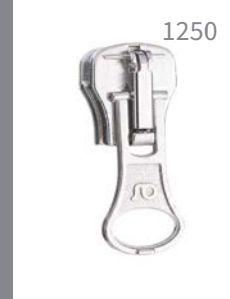

Löffelgriff



Leine

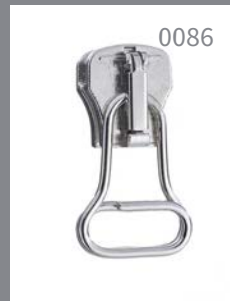

Drahtschlaufe

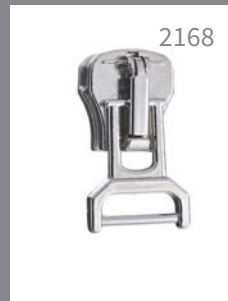

NA 113

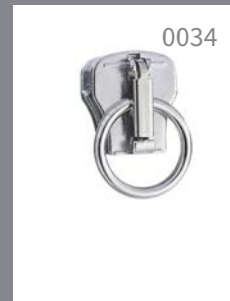

direkter Ring



automatischer  
Wendeschieber



Zwischenglied

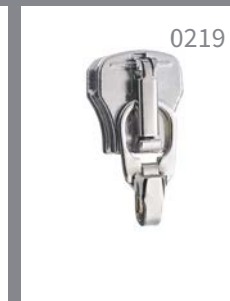

Karabinerhaken

### Basic types of non locking sliders



loser Bügelschieber  
mit Ring

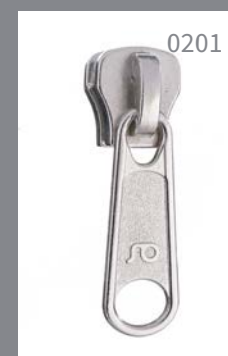

loser Bügelschieber

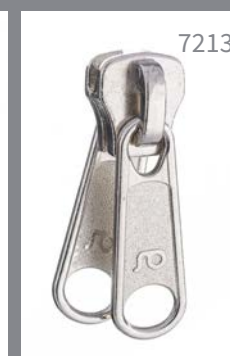

loser Wendeschieber

## Teeth surfaces PK 10

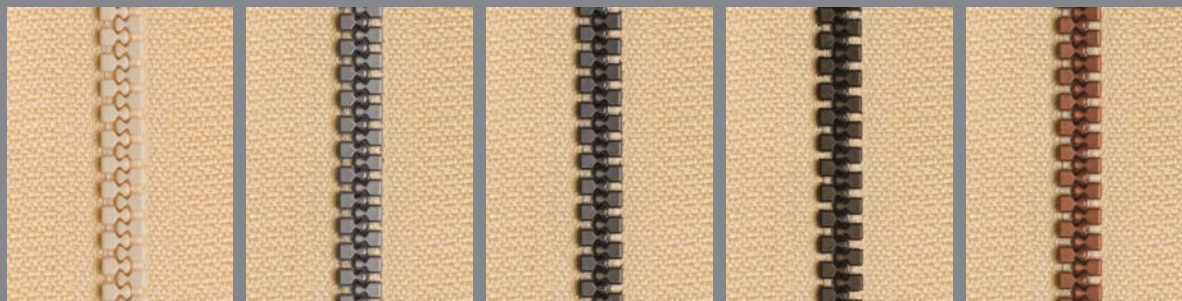

unicoloured

aluminium

oxide

gun-metal

copper

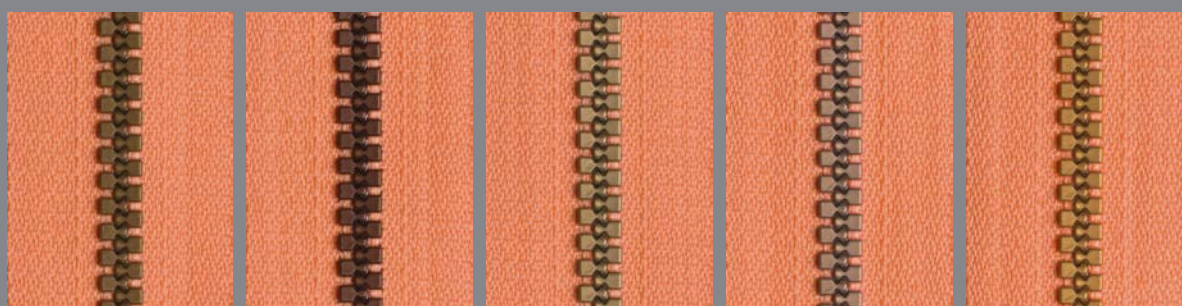

old brass

old copper

silver-brass-dull

silver-copper-dull

gold-copper

more colour combinations on page 28

typographical colour differences and those depending on production lots are possible



## PK 20

teeth: 8,7 mm  
tape: 18 mm,  
20 mm for zippers for tents

for heavy clothing, sportswear,  
camping- and boat accessories,  
awnings, technical uses

available as type A, B, C, D

### Basic types of automatic sliders



Standard

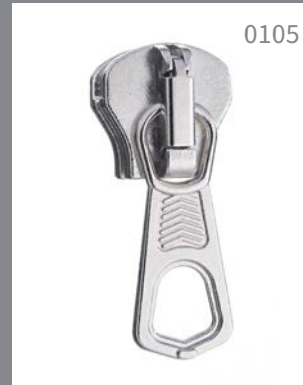

konischer Griff

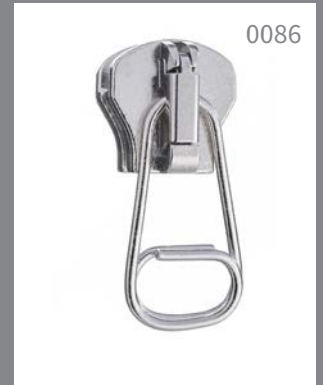

Drahtschlaufe

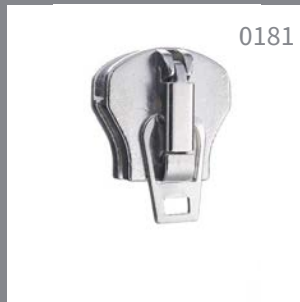

Zwischenglied

### Basic types of non locking sliders



loser Bügelschieber

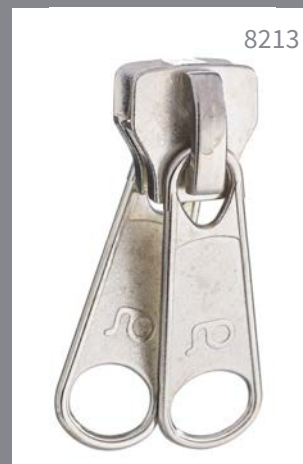

loser Wendeschieber



## Teeth surfaces PK 20

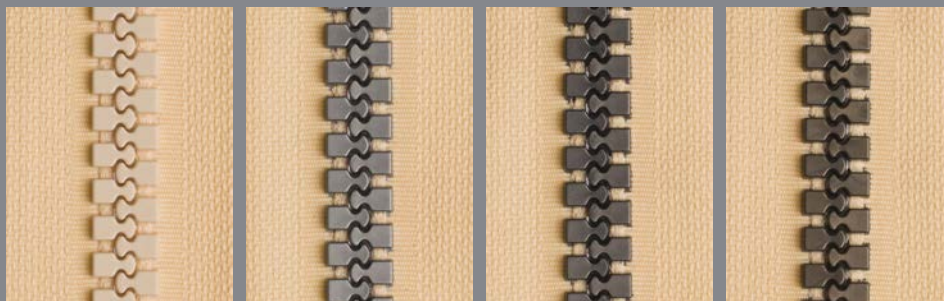

unicoloured

aluminium

oxide

gun-metal

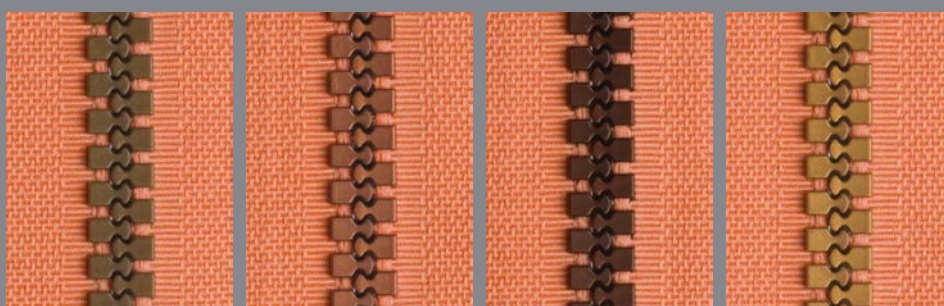

old brass

copper

old copper

gold-copper

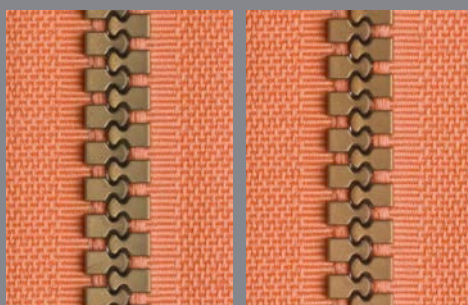

silver-brass-dull

silver-copper-dull

more colour combinations on page 28  
typographical colour differences and those depending on production lots are possible

## Multicoloured delrin zipper



option 1

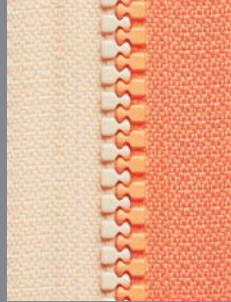

option 2

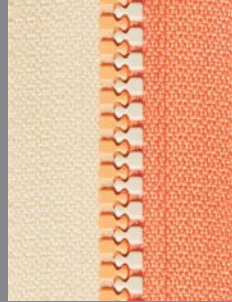

option 3



option 4



different-coloured slider

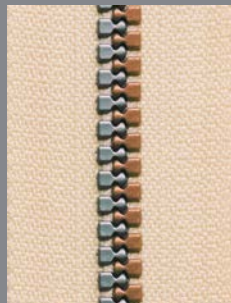

all teeth surfaces combinable e.g. aluminium/copper

available as type PK 10/PK 20

## Rhinestone zipper

only for gentle usage



rhinestone zipper black



rhinestone zipper white



rhinestone puller with 3 stones

typographical colour differences and those depending on production lots are possible



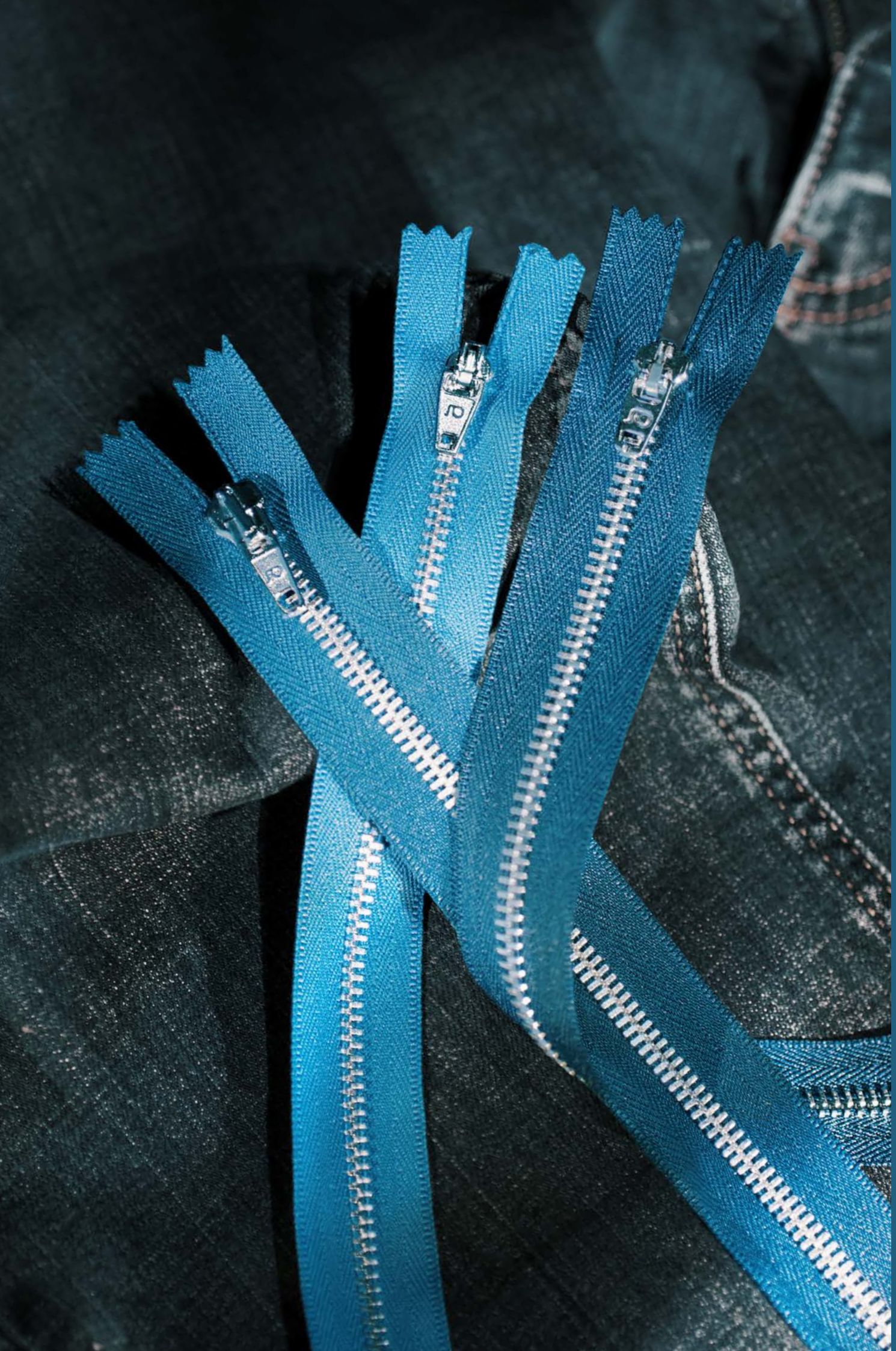

**Metal zipper**



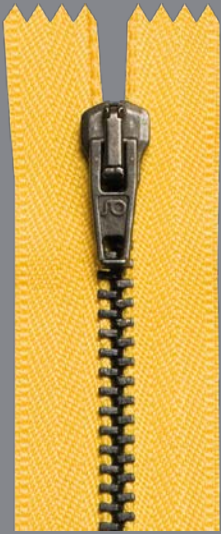

## Basic types of automatic sliders

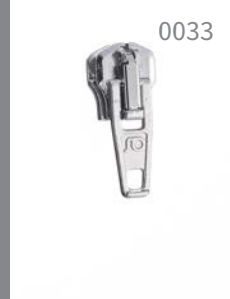

Standard



Tropfen

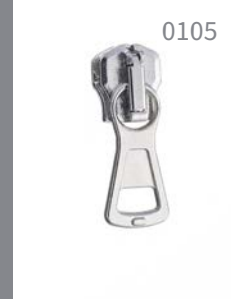

konischer Griff



Löffelgriff

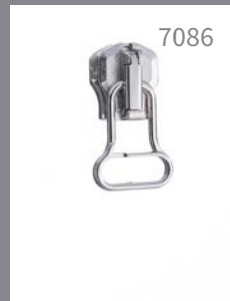

Drahtschleufe

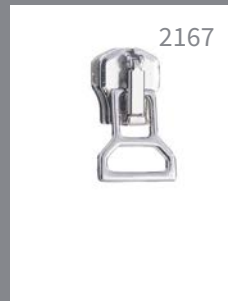

NA 100

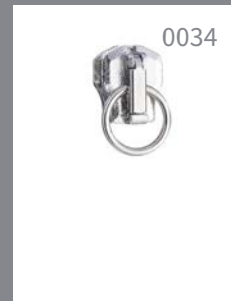

direkter Ring



Semiautomatik



Zwischenglied

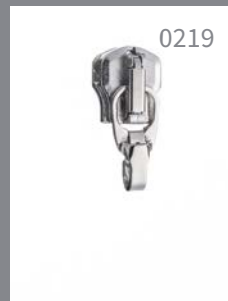

Karabinerhaken

## Basic types of non locking sliders

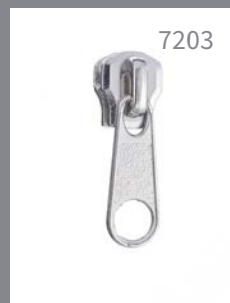

loser Bügelschieber

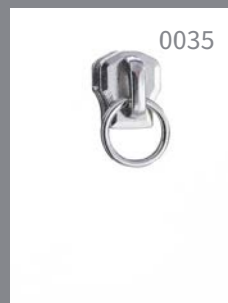

loser Bügelschieber  
mit Ring

## MO

teeth: 4,5 mm  
polyester tape: 12 mm

cotton tape: 12 mm  
only off-white for PPT dyeing  
brass and copper only

for gentle clothing, jeanswear

available as type A, B, C, D, F





## Teeth surfaces M O



brass

old-brass

black-brass

old-silver

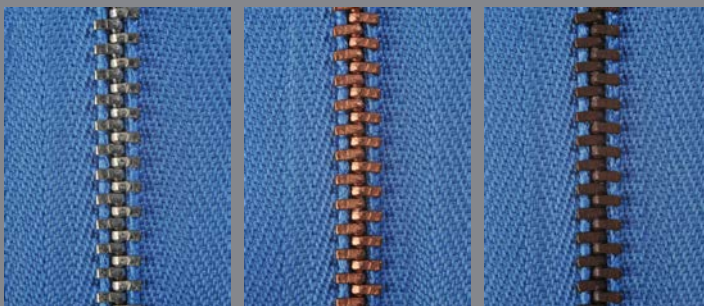

silver

copper

old-copper



bicoloured tape  
(possible for all surfaces)

typographical colour differences and those depending on production lots are possible

# Metal Zipper

## Basic types of automatic sliders



**M 10 /  
MS 10**

teeth: 6 mm  
polyester tape: 15 mm

cotton tape: 15 mm  
only raw white for PPT dying  
brass only

for middle and heavier clothing,  
sportswear, workwear, jeanswear

M 10 available as type A, B  
MS 10 available as type A, B, C, D, F



Standard

konischer Griff

Löffelgriff

Leine



Drahtschlaufe

NA 113

direkter Ring

Semiautomatik



Zwischenglied

Karabinerhaken

autom.  
Wendeschieber

## Basic types of non locking sliders



loser Bügelschieber

loser Bügelschieber  
mit Ring

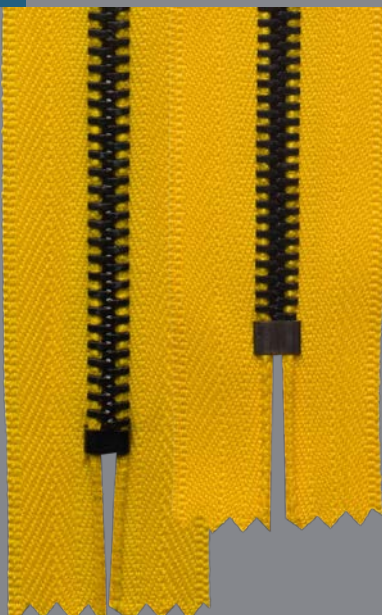



## Teeth surfaces M 10



brass

old-brass

black-brass

old-silver  
in the metal surface of  
old silver colour  
deviations can occur



silver

bicoloured tape  
(possible for all surfaces)

## Teeth surfaces MS 10

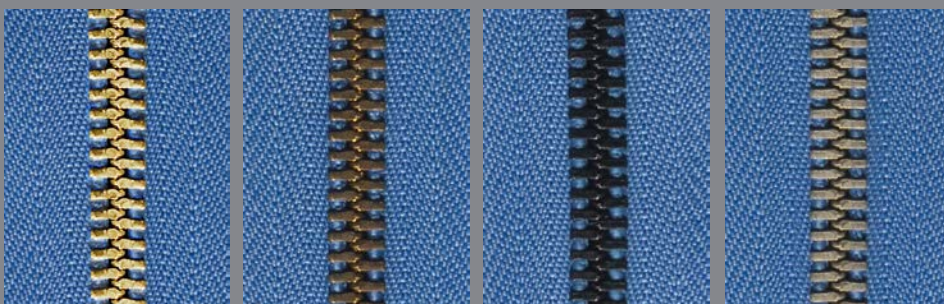

brass

old-brass

black-brass

old-silver  
in the metal surface of  
old silver colour  
deviations can occur



silver

bicoloured t ape  
(possible for all surfaces)







**Pullers**



# Metal pullers for mounting at slider 0181



kleine Leiste



Tropfen groß



Tropfen klein

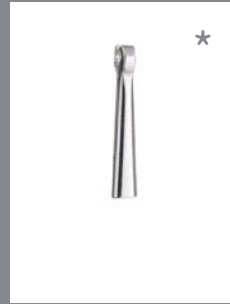

Turbo \*



Trapez \*

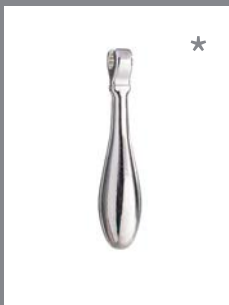

Keule \*



Welle Standard



Welle groß



Welle klein



Strip \*



Flask groß



Flask klein



Stab groß



Stab klein \*



Bogen groß



Bogen klein

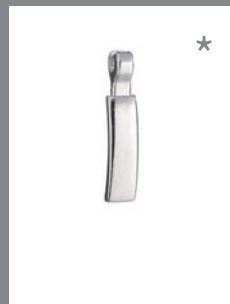

Bogen mini \*

Surfaces see pages 54/55

\* mountable at zipper PN 0



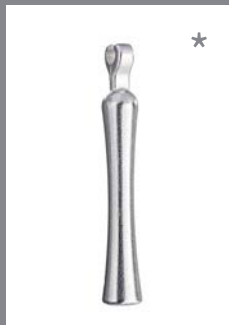

E2181



E2174

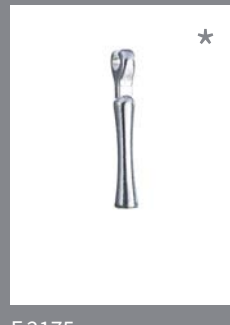

E2175



Keil groß



Keil klein



J 25779 groß



J 25779 klein



Ute

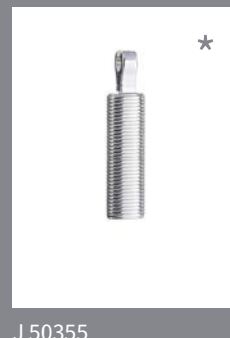

J 50355

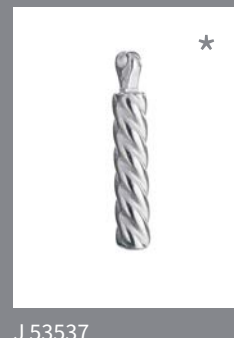

J 53537

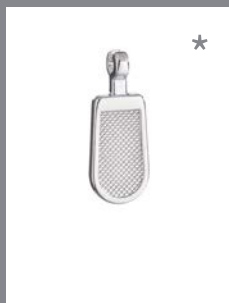

Eva



Ozean



Edda

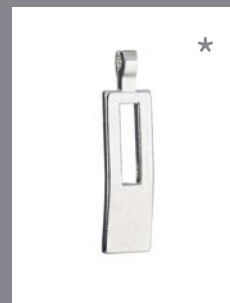

Rechteck



615



Leistengriff



abgeschrägter  
Tropfen



Kugelstab

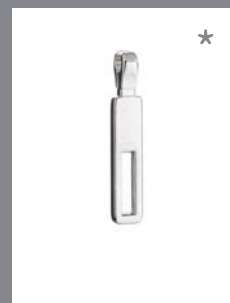

J 29087



J 43926

Surfaces see pages 54/55

\* mountable at zipper PN 0



# Metal pullers for mounting at slider 0181

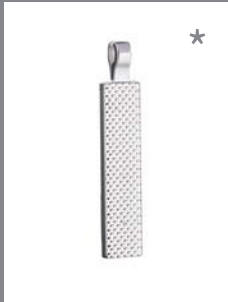

J 45824 groß

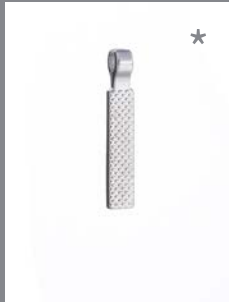

J 45824 klein



Z 2349 groß



Z 2349 klein

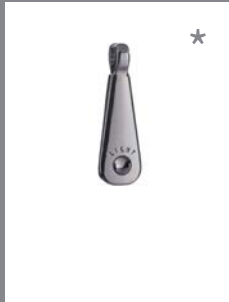

J 43927



J 41771



CK 967

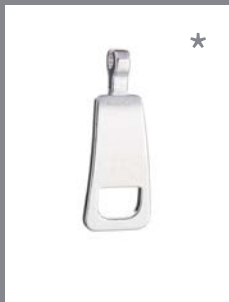

Z 1629

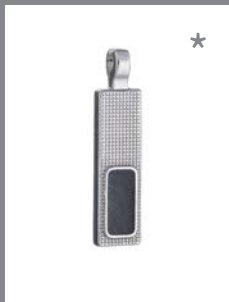

J 44861 groß

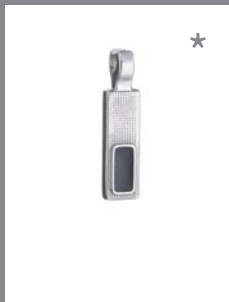

J 44861 klein

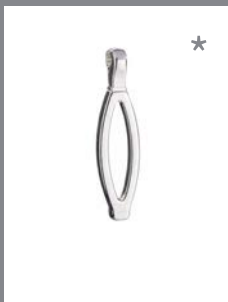

H 21758 groß

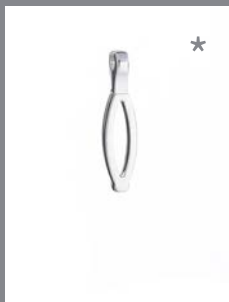

H 21758 klein

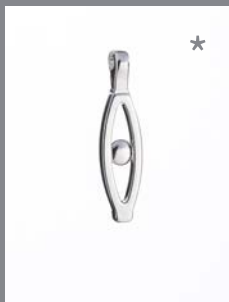

H 21757 groß

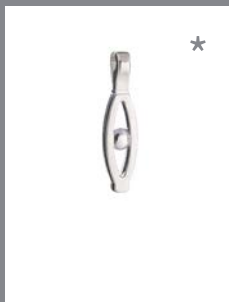

H 21757 klein

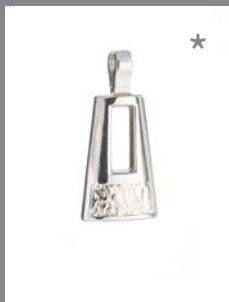

CK 965

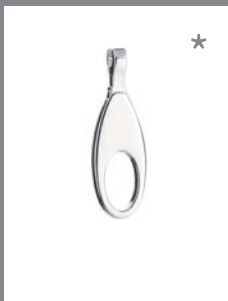

H 21756 groß

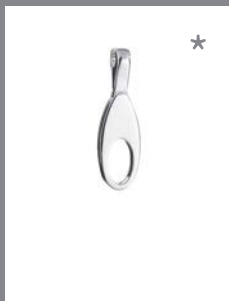

H 21756 klein

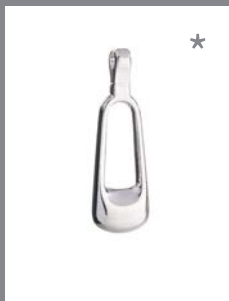

J 16231

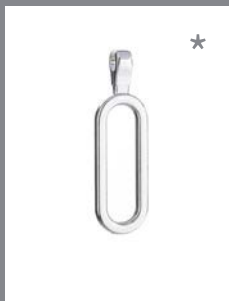

J 24832



J 26165

Surfaces see pages 54/55

\* mountable at zipper PN 0





Rundgriff groß



Rundgriff mittel

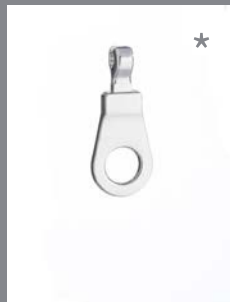

Rundgriff klein

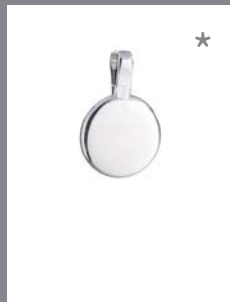

Knopf groß

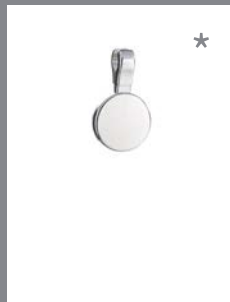

Knopf klein



Disc groß

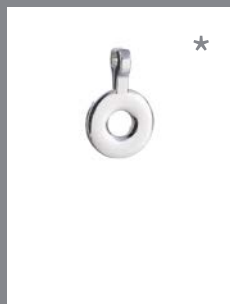

Disc klein



Ring groß



Ring klein

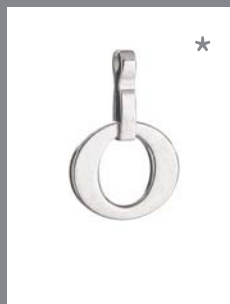

Dixi



H 18092



Quadrat groß

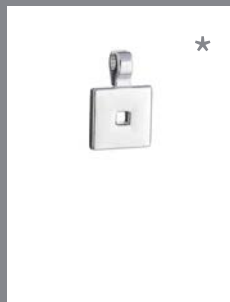

Quadrat klein

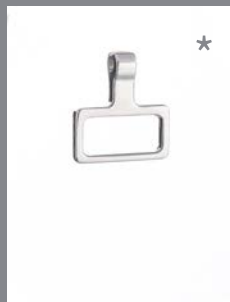

Rechteckschlaufe  
groß

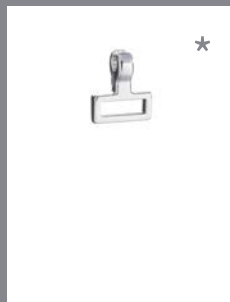

Rechteckschlaufe  
klein



V 1802/13/032

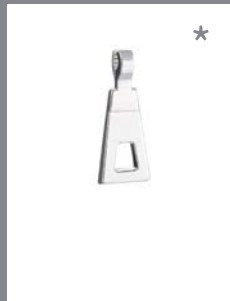

Dreieck

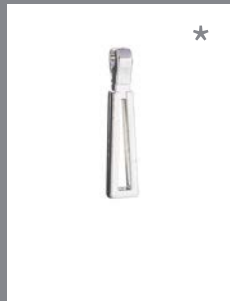

J 19538

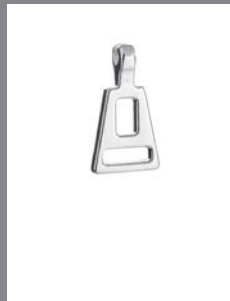

J 23251

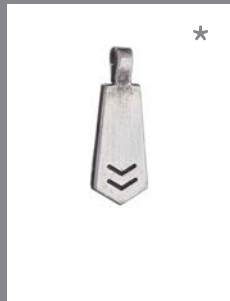

J 24998

Surfaces see pages 54/55

\* mountable at zipper PN 0



# Metal pullers for mounting at slider 0181



V 1802/13/031

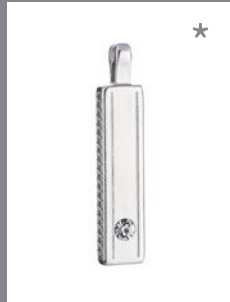

B2254095 silver,  
silver-dull



HS 40216  
silver, black-brass

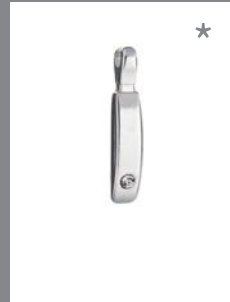

S 09495539



Strassknopf groß /  
silver, gun-metal,  
brass, ice-gold,  
black-brass

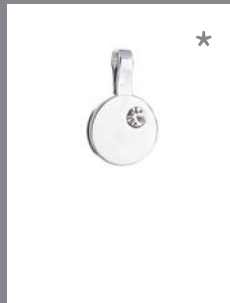

Strassknopf klein  
silver, black-brass



J 47074 fb. 0170



J 47074 fb. 0135



Herz

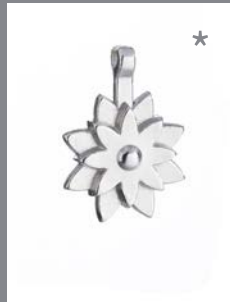

E 2185



Lilie

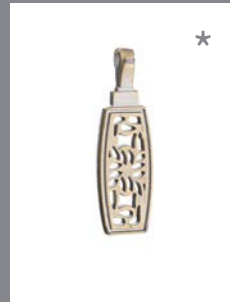

HS 38804



HS 43189 groß



HS 43189 klein



HS 42711

We colourise these zippers like our colourcard for order quantities about 25 pieces.

Surfaces see pages 54/55

\* mountable at zipper PN 0



# Pullers from plastics or synthetic leather for mounting at slider 0181



J 31347  
also in white

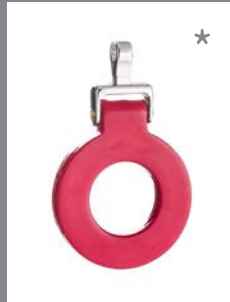

J 31347



J 31346  
also in white



J 31346



K 585 reflex



K 584 reflex

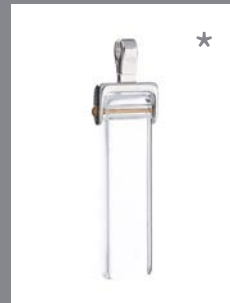

0605 Kunststoff

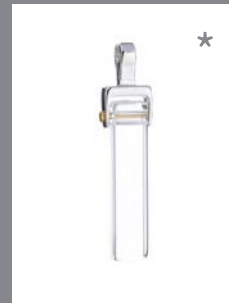

0608 Kunststoff



Reflexschlaufe  
metallic K 228



Kordel K967



Kordel 1408 groß

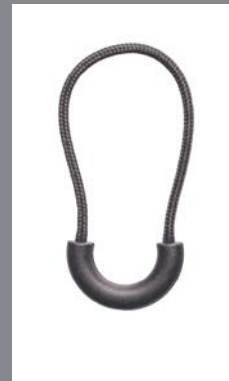

Kordel 1408 klein

typographical colour differences and those depending on production lots are possible

\*mountable at zipper PN 0



# Pullers from plastics or rubber material for mounting at slider 0181



Gummistab schwarz



Gummistab transparent



Gummigriff schwarz



Gummigriff transparent

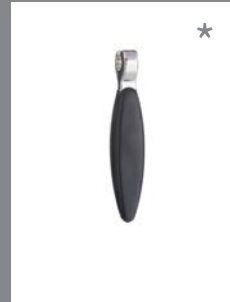

Gummitropfen  
claw in dark colour too



V 1308/13/006  
gummiert



V 1308/13/003  
gummiert



J 24843 gummiert

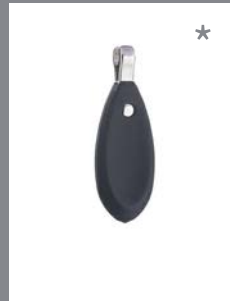

J 24840 gummiert

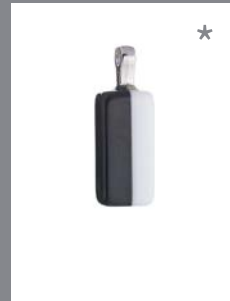

schwarz/weiß  
Kunststoff



K503 rubber (also possible in white)



K045 plastic (also possible in transparent)



K195 (also possible in transparent)

typographical colour differences and those depending on production lots are possible



# Pullers from synthetic leather for mounting at slider 0181



J 25797 beige patent leather

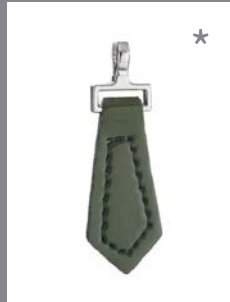

J 25797 green patent leather



J 25797 white patent leather



J 25797 black patent leather

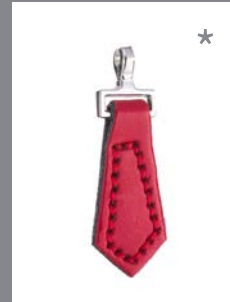

J 25797 red patent leather



J 53625



J 53626



J 25652 black patent leather



J 25652 red patent leather



K 474 medium brown, dark brown, black

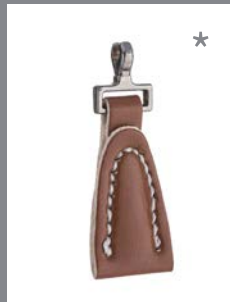

K 384 medium brown, dark brown, black



J 97439



typographical colour differences and those depending on production lots are possible

\* mountable at zipper PN 0

# Pullers

for mounting directly at automatic slider



Pyramide groß  
size 20



Pyramide mittel  
size 10



Pyramide klein  
size 0 and size 10



Krawatte  
size 0/10/20



J 48799 groß  
size 20



J 48799 mittel  
size 0 and size 10

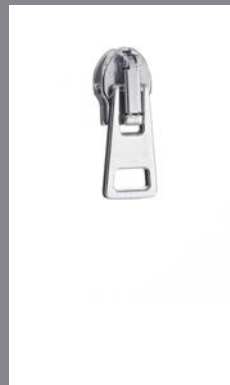

J 48799 klein  
size 0



Ellipse groß  
size 20



Ellipse mittel  
size 0 and size 10



Ellipse klein  
size 0 and size 10

sizes

mountable on all variants  
for zipper-types  
size 0 - PR 0, M 0  
size 10 - P 10, PK 10, M 10, MS 10  
size 20 - P 20, PK 20

# Pullers

for mounting directly at automatic slider



J 48410 groß  
size 10



J48410 klein  
size 0



Bag groß  
size 0 and size 10



Bag klein  
size 0 and size 10

sizes

mountable on all variants  
for zipper-types  
size 0 - PR0, M0  
size 10 - P10, PK10, M10, MS10  
size 20 - P20, PK20



DA 0027  
size 0 and size 10



DA 0029  
size 0 and size 10



DA 147  
size 0 and size 10

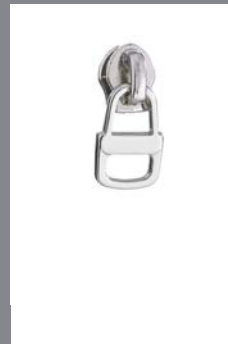

V 1802/13/062  
size 0 and size 10

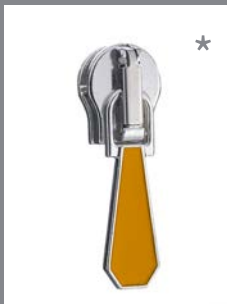

V 2201/13/033  
size 0 and size 10



J 26172  
size 0 and size 10

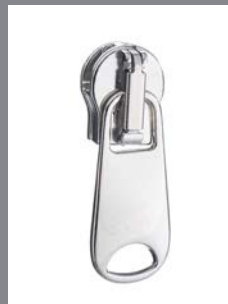

J 46939  
size 0 and size 10



J 48311  
size 0 and size 10

\* We colourise these zippers like our colourcard for order quantities about 300 pieces.



# Pullers

for mounting directly at automatic slider



E 9714  
size 0 and size 10



J 48806  
size 10



V 0302/13/029  
size 0 and size 10



V 1001/13/052  
size 0 and size 10

sizes

mountable on all variants  
for zipper-types  
size 0 - PR 0, M 0  
size 10 - P 10, PK 10, M 10, MS 10  
size 20 - P 20, PK 20

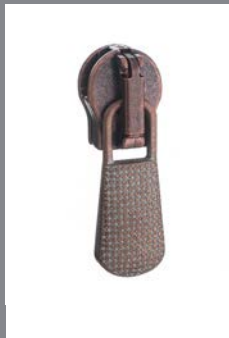

J 50227  
size 0 and size 10



J 44714  
size 10

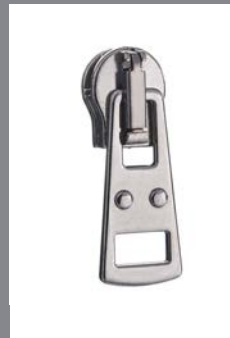

J 39102  
size 10



U 59748  
size 0 and size 10

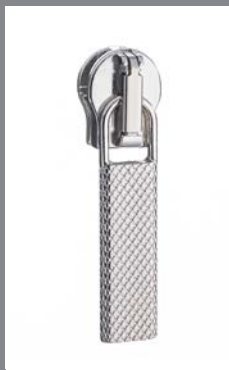

St 84326 groß  
size 10

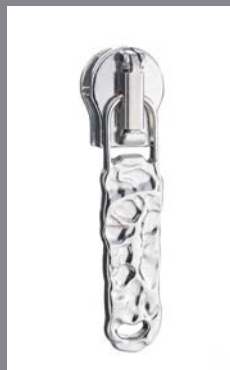

V 1001/13/050  
size 0 and size 10



J 41914  
size 0

Pullers



J 35163  
size 10



J 35161  
size 10

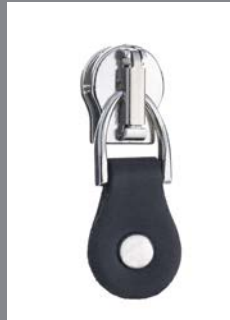

J 94533  
size 10

sizes

mountable on all variants  
for zipper-types  
size 0 - PR0, M0  
size 10 - P10, PK10, M10, MS10  
size 20 - P20, PK20

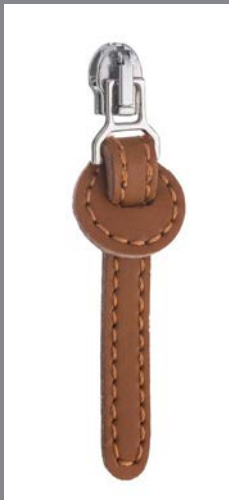

medium brown  
colour 043

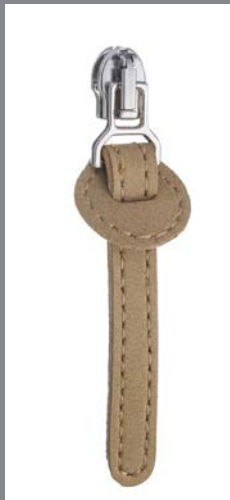

beige  
colour 011

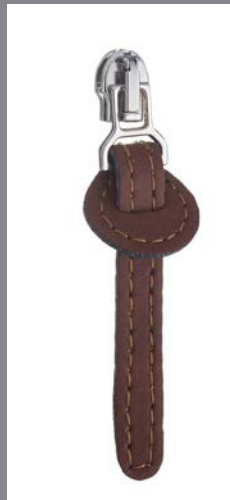

dark brown  
colour 041



black  
colour 099



J 52087  
size 10



K 390  
size 10

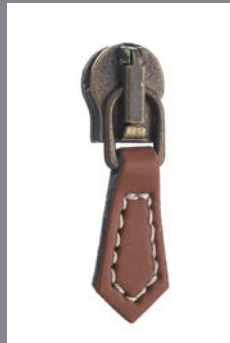

K 480  
size 10

# Pullers

for mounting at non-locking slider



Pyramide groß  
size 20



Pyramide mittel  
size 0 and size 10



Pyramide klein  
size 0



Krawatte  
size 0/10/20

sizes

mountable on all variants  
for zipper-types  
size 0 - PR0, M0  
size 10 - P10, PK10, M10, MS10  
size 20 - P20, PK20



J 48799 groß  
size 10 and size 20



J 48799 mittel  
size 10 and size 20

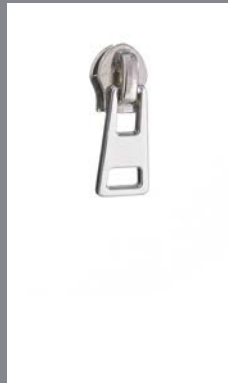

J 48799 klein  
size 0 and size 10



Ellipse groß  
size 20



Ellipse mittel  
size 0 and size 10

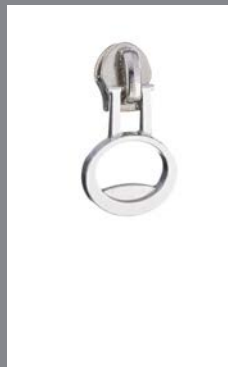

Ellipse klein  
size 0



# Pullers for mounting at non-locking slider



V 1001/13/052  
size 0 and size 10



V 1001/13/050  
size 0 and size 10



J 41914  
size 0 and size 10



J 26172  
size 0 and size 10

sizes  
mountable on all variants  
for zipper-types  
size 0 - PR0, M0  
size 10 - P 10, PK 10, M 10, MS 10  
size 20 - P 20, PK 20



DA 0027  
size 0 and size 10



DA 0029  
size 0 and size 10



J 26162  
size 0 and size 10



V 2201/13/033  
size 0 and size 10



St 84326 groß  
size 0 and size 10



St 84326 klein  
size 0 and size 10



Bag groß  
size 0 and size 10



Bag klein  
size 0 and size 10

\* We colourise these zippers like our colourcard for order quantities about 300 pieces.

# Pullers

for mounting at non-locking slider



U 59507  
size 0 and size 10



V 0201/13/013  
size 0 and size 10



J 46939  
size 0 and size 10



CK 274  
size 10



DA 147  
size 0 and size 10

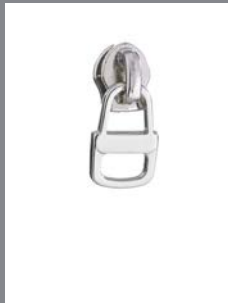

V 1802/13/062  
size 0 and size 10



J 48311  
size 0 and size 10



E 1819  
size 0 and size 10

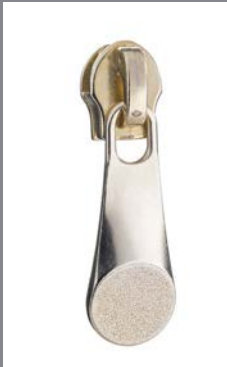

HS 43096  
size 0 and size 10

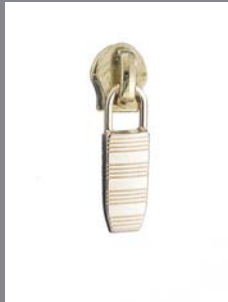

J 52928  
size 0 and size 10

sizes

mountable on all variants  
for zipper-types  
size 0 - PR 0, M 0  
size 10 - P 10, PK 10, M 10, MS 10  
size 20 - P 20, PK 20

Pullers

# Pullers for mounting at non-locking slider



U 059748  
size 0 and size 10



J 39102  
size 0 and size 10



J 48410 groß  
size 0 and size 10



J 48410 klein  
size 0 and size 10

sizes  
mountable on all variants  
for zipper-types  
size 0 - PR0, M0  
size 10 - P10, PK10, M10, MS10  
size 20 - P20, PK20



E 9714  
size 0 and size 10



J 41597  
size 0 and size 10



J 48525  
size 0 and size 10



T 147992  
size 0 and size 10



T 148025  
size 0 and size 10



J 44714  
size 0 and size 10

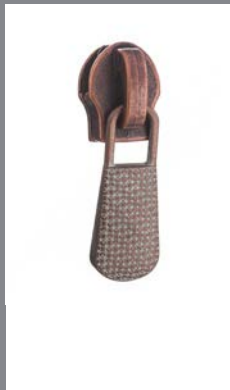

J 50227  
size 0 and size 10

Pullers



# Pullers

for mounting at non-locking slider



J 48806  
size 0 and size 10



J 52439  
size 0 and size 10



V 0302/13/029  
size 0 and size 10

sizes

mountable on all variants  
for zipper-types  
size 0 - PR 0, M 0  
size 10 - P 10, PK 10, M 10, MS 10  
size 20 - P 20, PK 20



J 35163  
size 0 and size 10



J 52087  
size 0 and size 10



K 390  
size 0 and size 10



J 94533  
size 0 and size 10



J 35161  
size 0 and size 10

Pullers



# Surfaces of sliders

We offer sliders in the following surfaces:

## Standard surfaces



silver



old silver



aluminium



brass



old brass



black-brass



copper



old copper



oxide



laquered

General information

typographical colour differences and those depending on production lots are possible



Special surfaces



gold plated



ice-gold



gold copper



silver dull



gun-metal



silver-brass-dull



silver-copper-dull

We offer you following services:

- laser your logo on one of our pullers
- building a tool for a new puller according to your perceptions at our tool construction and fabrication of the puller at our own foundry

typographical colour differences and those depending on production lots are possible

General information

# Chain and sliders

We deliver chain and sliders in the following types:

Type	Width	Packaging per roll
PR 0	12 mm	200 m
PR 0	16 mm*	200 m
W 0 (Webkette)	9 mm*	200 m
W 0 (Webkette)	12 mm*	200 m
P 10	16 mm	150 m
P 10	20 mm*	100 m
P 10	27 mm (black only)	50 m
W 10 (Webkette)	16 mm*	150 m
P 20	20 mm*	50 m
P 25	20 mm*	50 m
PK 10	15 mm	150 m
PK 20	18 mm*	50 m
PK 20	20 mm*	50 m
M 0 **	12 mm	200 m
M 10 ***	15 mm	150 m
MS 10	15 mm	150 m

\* limited range of colour

\*\* please specify when ordering as 2-way zipper

\*\*\* not usable as 2-way zipper

Chains are also available for the following products:  
mPR 0, mP 10, waPR 0, waP 10, trPR 0, trP 10, piping (half-sided)

You can find the corresponding sliders at the previous pages.

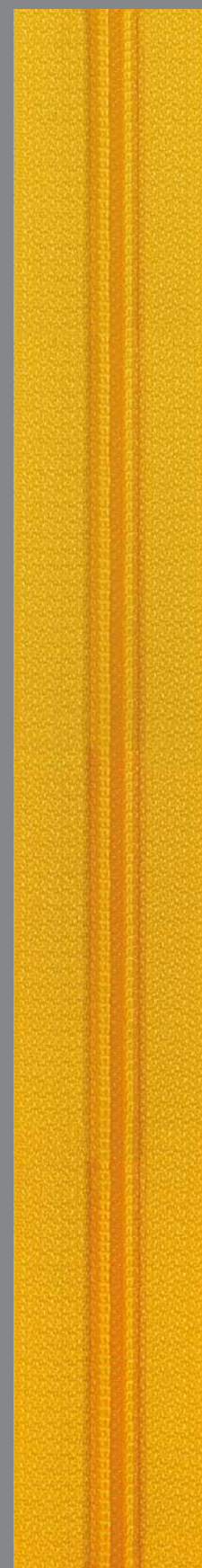

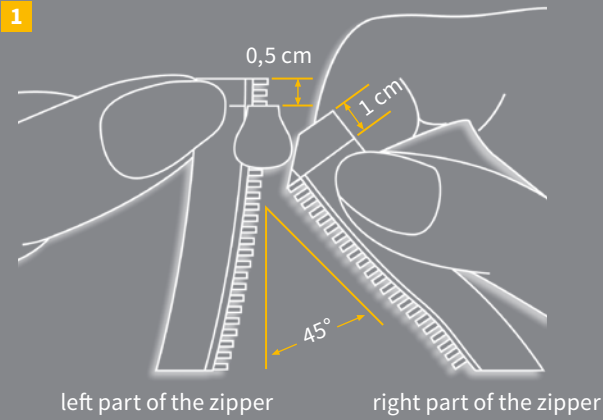

- 1** You have to separate the chain when it is loose or already sewed into another item. Then you have to cut the right half of the chain at an angle.

After you have pulled up the slider for 0,5 cm on the left half of the chain – you have to thread the cut right half of the chain into the slider in an angle of 45°.

You have to keep both ends of the chain below the slider and pull the slider on the chain for about 5 cm.

- 2** You have to pay attention to the fact that there is no mismatch between the both halves of the the chain. If necessary you have to pull off the slider and after correction of the halves to pull up it again.

- 3** For the whole operation you should use our special slider mounting device which you can fix at every table-top (e.g. sewing machine table).

Mounting plates are replaceable and available for many different sliders.

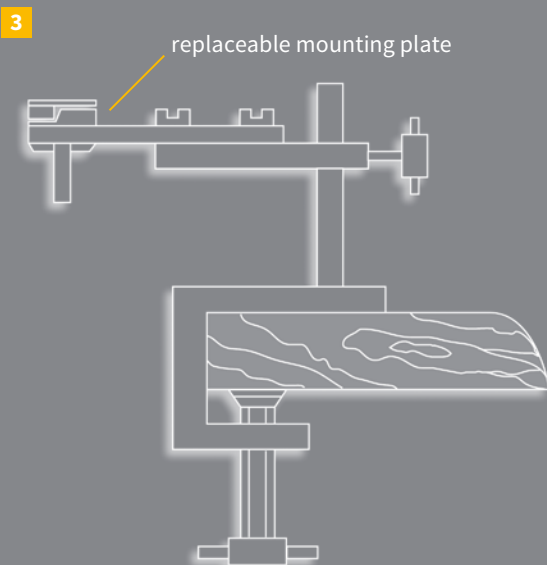
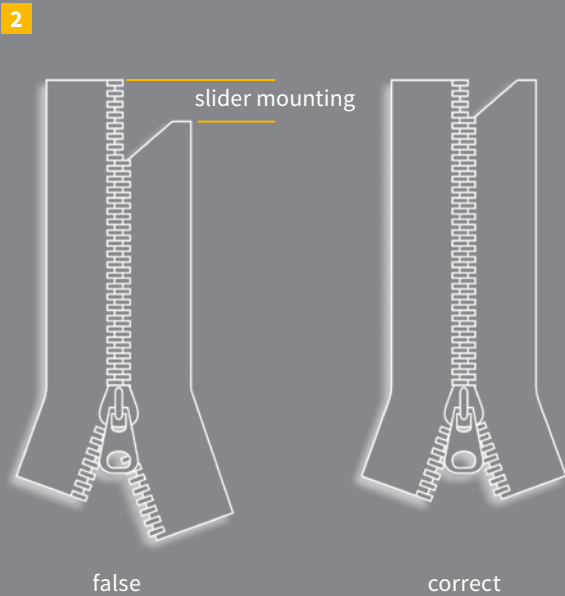



	PN 0	PR 0	P 10	P 20	P 25	PK 10	PK 20	M 0	M 10	MS 10
part of zipper										
tape	polyester									
coil	polyestermonofilament					-		-		
teeth	-					polyacetal		brass		
sewing thread	polyester					-		-		
Slider	fine zinc pressure cast alloy									

### Technical data (guaranteed minimum data in N)

	PN 0	PR 0	P 10	P 20	P 25	PK 10	PK 20	M 0	M 10	MS 10
puller attachment (only with metal puller)	80	80	200	250	300	200	250	80	200	200
security of inseparable zipper	40	60	80	120	150	60	120	60	80	80
security of attachment of top stop	60	70	90	150	150	90	150	70	90	90
security of attachment box		60	90	120	150	90	150	70	90	90
resistance of chain to lateral load	350	350	600	700	850	375	600	425	500	500
resistance of open end fitment to lateral load		70	100	160	200	100	200	90	100	100

washing and dry cleaning	     
--------------------------	--

Rights to make technical revision reserved.



**Schleswig-Holstein,  
Niedersachsen  
(außer PLZ 4827 bis 487.),  
Ostwestfalen-Lippe**

D. & A. Spilker-Meyer GbR  
Am Nordholz 12  
D-32130 Enger/Germany  
Tel.: +49 52 24 / 9 76 86 61  
Fax: +49 52 24 / 9 76 86 62  
E-Mail: am@spilker-meyer.de

**Hessen, Saarland, Rheinland-Pfalz,  
Raum Aschaffenburg**

KS-Faktorei  
Kludia Stein e.K.  
Am Rathaus 2  
D-65624 Altendiez/Germany  
Tel.: +49 64 32 / 8 84 70  
Fax: +49 64 32 / 8 31 40  
E-Mail: kludia.stein@ks-faktorei.de

**Baden-Württemberg,  
Österreich (PLZ 5000-6999),  
deutschsprachige Schweiz**

Bitzer + Single GmbH  
Schillerstraße 15  
D-72458 Albstadt/Germany  
Tel.: +49 74 31 / 95 80 0  
Fax: +49 74 31 / 95 80 88  
E-Mail: info@bitzer-single.de

**Österreich  
(außer PLZ 5000-6999)**

Karl Knie  
Hauptstraße 14  
A-2202 Enzersfeld/Österreich  
Tel.: +43 22 62 / 67 32 77  
Fax: +43 22 62 / 67 32 77  
E-Mail: karl.knie@gmx.at

**Ruhrgebiet, Münsterland**

Industrievertretung  
Norbert van der Koelen  
Grünewaldstraße 9  
D-47623 Kevelaer/Germany  
Tel.: +49 28 32 / 9 27 40  
Fax: +49 28 32 / 9 27 42  
E-Mail: norbert@van-der-koelen.de

**Sachsen, Thüringen,  
Sachsen-Anhalt,  
Brandenburg,  
Mecklenburg-Vorpommern,  
Berlin**

Textilvertretung  
Michael Lehnert  
Freiberger Straße 52 a  
D-09575 Eppendorf/Germany  
Tel.: +49 3 72 93 / 7 14 00  
Fax: +49 3 72 93 / 7 14 10  
E-Mail: textilvertretung.lehnert@gmail.com

**Bayern**

Textilagentur  
Christoph Obelt  
Postfach 2265  
D-96013 Bamberg/Germany  
Tel.: +49 9 51 / 9 18 02 39  
Fax: +49 9 51 / 9 18 02 49  
E-Mail: textilagentur@obelt.de



**Heiligenstädter Reißverschluß GmbH & Co. KG**

Rengelröder Weg 33 · 37308 Heilbad Heiligenstadt/Germany · Phone: +49 3606 / 55 221-0 or +49 3606 / 55 221-84  
Fax: +49 3606 / 55 221-82 · E-Mail: [info@h-rv.de](mailto:info@h-rv.de) · Internet: [www.h-rv.de](http://www.h-rv.de)

edition: April 2017